

Installing the Enphase Three Phase NPR

The Enphase Three Phase Network Protection Relay™ (NPR) allows installation of single-phase Enphase IQ Series Microinverters™ in a three-phase (208/120 VAC) system by providing a consistent, pre-wired protection solution for three-phase commercial 208/120 VAC applications. To install the Three Phase NPR, read and follow all warnings and instructions in this guide. Safety warnings are listed on the back of this guide. Professional installation is recommended.

The Three Phase NPR is an outdoor-rated, NEMA type 4 enclosure containing an Enphase IQ Envoy™, Enphase Mobile Connect, LTE-M cell modem, isolation contactor, contact controller, backup power supply, terminal lugs, and wiring for IQ Envoy connections. The NPR also contains Production CTs, wired to the included IQ Envoy. Use the Three Phase NPR to support the AC connections needed for an Enphase commercial solar installation.

The Three Phase NPR provides electrical connection between a three-phase electrical grid, and a three-phase PV array. During connection, it monitors voltages on all three phases, and if conditions occur (loss of phase, under/over voltage, etc.) that require disconnection, removes the grid-to-array connection of all three phases. Operation is automatic with no setting or manual intervention. The Enphase IQ Envoy requires configuration setup as described in this guide.

How It Works

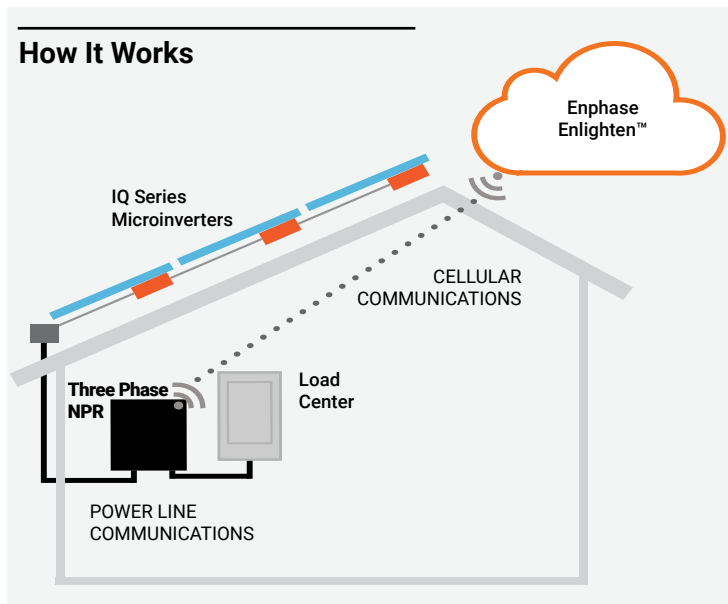

PREPARATION, continued

- E) Decide how to connect the IQ Envoy to the Internet: Use the included Enphase Mobile Connect modem, wi-fi, or Ethernet. If using Ethernet, make sure you have the following items
- Ethernet cable: 802.3, Cat5E or Cat6, unshielded twisted pair (UTP). Do not use shielded twisted pair (STP) cable.
 - Ethernet requires that you install a ferrite bead (we recommend Fair-Rite 0431167281) as close as possible to the IQ Envoy on the Ethernet cable.
- F) Create a paper installation map to record device serial numbers and positions in the array. You will scan this map later using Installer Toolkit and your mobile device.
- Write the IQ Envoy serial number on the paper installation map. Later, you will need to enter this number in Installer Toolkit. You can type it in manually or scan the label on the inside of the NPR door.
- G) Choose a mounting location that is structurally suited to bearing the weight of the unit. The wall must include studs that can bear 29 kg (64 lbs) or can be of masonry or other suitable structure.

WARNING: The Three Phase NPR weighs 29 kg (64 lbs) and may require two persons to lift the unit.

NOTE: If needed, you can find an installation map at the back of any Enphase Microinverter Quick Install Guide.

PREPARATION

- A) Download the Enphase Installer Toolkit mobile app and open it to log on to your Enlighten account. With this app, you can connect to the IQ Envoy to track system installation progress. To download, go to enphase.com/toolkit or scan the QR code at right.
- B) Consumption metering is optional. If desired, consumption CTs are required (not included with NPR) and are installed in the system breaker panel, then wired into the NPR. Check the box for the following items:
- Enphase Three Phase NPR (IQ Envoy and LTE-M cell modem included and integrated within NPR)
 - *Enphase Three Phase NPR Quick Install Guide* (this document)
- C) Make sure you have the following **required** items:
- Tools: screwdriver, Allen wrenches (5/16 & 7/16), pliers, and stepped bit drill.
 - Overcurrent protection in the load center in accordance with NFPA 70, §705.12.
 - Suitable mounting hardware: use #10 (or larger) screws that are long enough to secure the unit to the vertical mounting surface
 - Copper conductors rated for wet locations and sized to meet local code requirements and voltage drop/rise considerations. Torque values are listed on the label inside the unit.
 - UL-listed rain-tight hubs for wire entry into the enclosure.
 - Up to four padlocks as needed, to lock the Three Phase NPR cabinet.
- D) Consumption metering is optional. If desired, consumption CTs are required (not included with NPR) and are installed in the system breaker panel, then wired into the NPR. To do consumption metering (production metering is already included in NPR):
- Make sure you order three split-core consumption metering CTs (order CT-200-SPLIT).
 - Check that there is enough space in the load center to install CTs. Do not install the CTs in a panel where they exceed 75% of the wiring space of any cross-sectional area within the load center.



INSTALLATION – Part 1

Note that following instructions outline installation of the Three Phase NPR in two parts. To ensure successful device detection, complete Part 2 after installing Enphase IQ Microinverters and/or Enphase Battery(ies).

Complete Installation Part 1 before installing Enphase Microinverters.

1 Choose a Location and Install Mounting Bracket

- A) Choose a vertical surface in a readily accessible location, at least three feet (91 cm) off the ground if outdoors. Plan to install the Three Phase NPR at least 12 inches (30.5 cm) off the ground if installed indoors.
- B) Consider the dimensions of the Three Phase NPR, easy access, box height, and length of cable when selecting the location. The Three Phase NPR is rainproof but not watertight.

NOTE: You must mount the Three-Phase NPR within 15° of vertical.

- C) The Three Phase NPR is shipped with its mounting brackets wrapped and tied within the unit. After unboxing, open the door, remove the bag that contains the four mounting brackets and their screws, and install them into the screw inserts on the back of the enclosure.



148-88152-82

2 Drill Holes to Accept Conduit



Warning! Risk of equipment damage. Do not drill conduit holes on the top of the box or at any location that allows moisture ingress.



Warning! Risk of electric shock. To maintain the warranty, do not modify the cover.

- A) Unlock and open the Three-Phase NPR cover.
- B) See the Conduit Entry diagram for the best locations to drill holes for conduit fittings.

NOTE: When drilling, consider the internal parts of the NPR. Make sure that the holes do not interfere with the internal workings, mechanics, or the cover legs in the corners of the NPR.

Best Practice: Use a stepped drill bit to make the conduit holes. Using a hole saw may crack the plastic housing. As an alternative, use a sharp chassis punch with caution.

- C) Use a snap punch or other type of center punch to prevent the drill from wandering. Drill a pilot hole with a smaller drill before using a step drill bit.
- D) Use only UL-listed rain-tight hubs for wire entry into the enclosure.

Conduit entry diagram

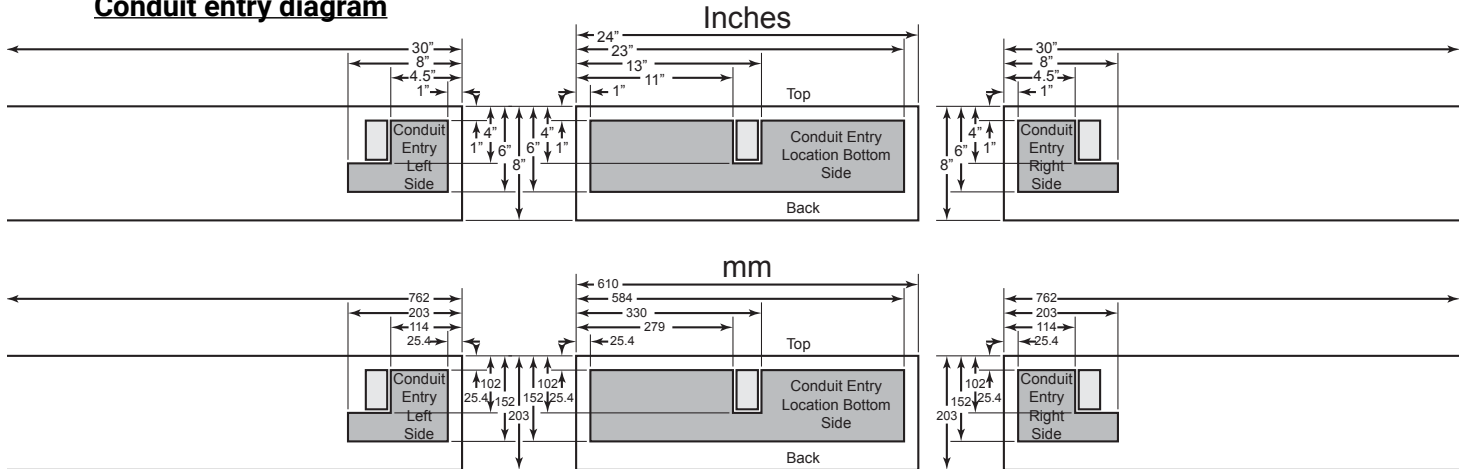

3 Wire the Grid Connections



Warning! Risk of equipment damage. Observe bend radius requirements when routing wires.

- A) Use conductors sized per local code requirements taking into consideration the voltage drop/rise and upstream breaker or fuse. The terminals accept wire range 1/0 to 250kcmil. Wires must be Class B or Class C only, and conductors with finer strands are not approved. Note that the rated maximum breaker size is 250 A.
- B) The terminal lugs on the left with four terminals are for the grid connection. Install L1 into the left-most terminal, L2 into the second from the left, L3 into the third from left and neutral at the remaining terminal. These connections require a 7/16 Allen wrench.

NOTE: Enphase IQ Series Microinverters use a two-wire system and do not use a Neutral. However, the IQ Envoy in the NPR still requires a Neutral from the load center.

- C) Connect the ground to a ground lug. Ground connections require a 5/16 Allen wrench.
- D) Torque all connections as indicated by the **Wiring Table**.

WIRING TABLE	
Grid/Array Connection	Torque
250kcmil - 3/0	275 lbs·in.
2/0 - #6	120 lbs·in.
Copper conductors only, rated minimum 90°C. Follow NFPA 70 (NEC) or CSA C22.1 part 1 and all local codes.	

4 Wire Inputs from the Array (AC Branch Circuits)

- A) Use copper conductors sized to meet local code requirements and voltage drop/rise considerations. The terminals accept wire range 1/0 to 250kcmil. Wires must be Class B or Class C only, and conductors with finer strands are not approved.
- B) Connect the ground (green or green/yellow) to a ground lug. Ground connections require a 5/16 Allen wrench, and accept a wire range of 4 to 2/0 AWG.
- C) The terminal lugs on the contactor (on the right side of the box) with three terminals are for the array connection. Install L1 into the left-most terminal, L2 into the center, and L3 into the right. These connections require a 7/16 Allen wrench.
- D) Connect the Array neutral, if required, to the terminal block shared with the Grid connections.
- E) Torque connections as indicated by the **Wiring Table**.

Wiring diagram

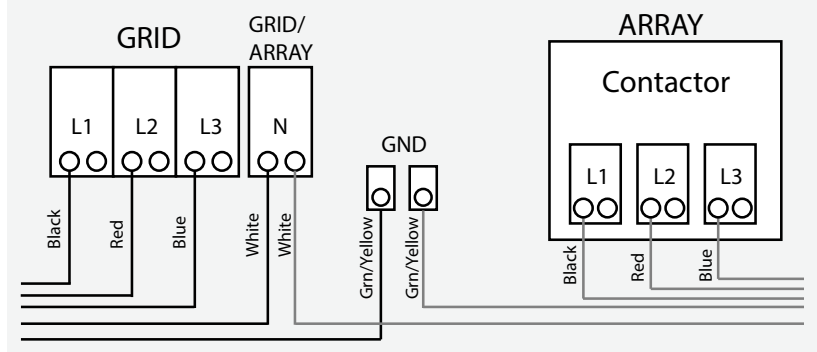

5 Install CTs for Consumption Metering (optional)

The IQ Envoy inside the Three Phase NPR is pre-wired at the terminal blocks for power and production metering connections. Three solid-core production current transformers (CTs) are pre-installed for revenue grade production metering. Consumption metering is supported, but consumption CTs are not included with the NPR. If consumption metering is desired, you can order and install three optional split-core CTs to provide consumption metering. Use a protected route in conduit for the CT wires from the system breaker panel to the IQ Commercial Envoy. The consumption CT leads are 13 feet long. If you need to extend the leads, refer to the *Enphase IQ Commercial Envoy Installation and Operation Manual* at: enphase.com/support. Do not extend the leads of the production CTs.

NOTE: Because of variance in load center design and main power feed, there may not always be enough space to install consumption metering CTs.

- Consumption CTs are installed in the system breaker panel, and their wires are routed into the NPR through wiring conduit. Refer to the diagram below. Make sure that the AC mains wire(s) are de-energized until you have secured the CT wires in the terminal blocks.
- Before running the CT wires through conduit, use colored tape to mark each of the CTs and the free ends of its wires, marking each with a different color. You can run multiple CT wires through a single conduit.
- Before installing the **consumption** CTs on active phases as required, locate the arrow on the CT label.
- To monitor consumption on Line 1:**
 - Connect the white wire to the white "C1" and the blue wire to the blue "C1" terminal.
 - Clamp the CT on the main supply Line 1. When the consumption CT is on Line 1 conductor, the arrow must point toward the load (away from the grid).
- To monitor consumption on Line 2:**
 - Connect the white wire to the white "C2" terminal and the blue wire to the blue "C2" terminal.
 - Clamp the CT on the main supply Line 2. When the consumption CT is on Line 2 conductor, the arrow must point toward the load (away from the grid).
- To monitor consumption on Line 3:**
 - Connect the white wire to the white "C3" terminal and the blue wire to the blue "C3" terminal.
 - Clamp the CT on the main supply Line 3. When the consumption CT is on Line 3 conductor, the arrow must point toward the load (away from the grid).
- Tighten all connections to 5 in-lbs (0.6 N m).**



DANGER! Risk of electric shock. Always de-energize the load center before beginning wiring.





DANGER! Risk of electrocution! Do not install CTs when current is flowing in the sensed circuit. Always install CT wires in the terminal blocks before energizing the sensed circuit.

NOTES: When installing CTs, it is important to match CT and sense voltage phases. Be sure to consistently identify the three AC lines at three points: the main load center feed, the Envoy, and the solar production circuit breaker. Wire colors (typically black, red, and blue) may not always consistently identify L1, L2, and L3. If in doubt, use a multimeter to check.

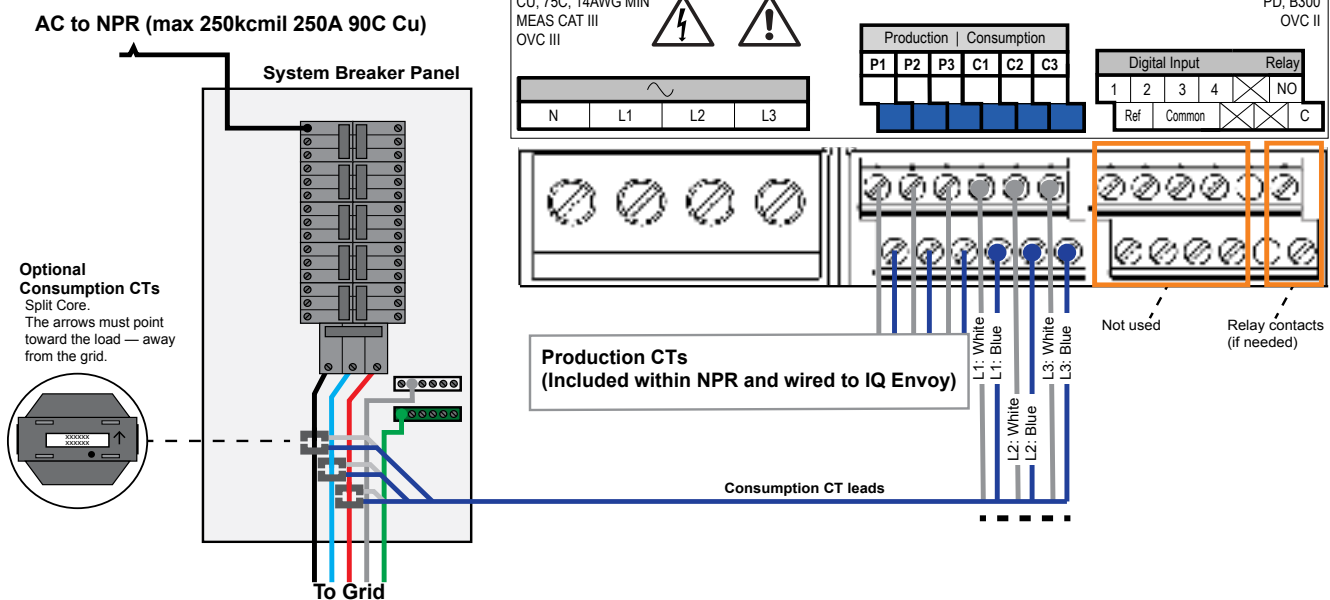
CT installation diagram



6 Energize and Update the IQ Envoy

- Turn on the circuit feeding the NPR.
- On the IQ Envoy (inside the NPR), if AP Mode LED  is not lit, press the AP Mode button.
- On your mobile device, go to Settings and join the Wi-Fi network "Envoy_nnnnnn" (where "nnnnnn" equals the final six digits of the Envoy serial number).
- The app informs you if the software on the Envoy is not the latest version by displaying the Envoy Software Update message. If the app displays this message, follow the on-screen instructions to update Envoy.
- For 5-10 minutes, you must keep your mobile device near the NPR. Follow the on-screen instructions while the update takes place. The update may take up to 20 minutes. The Envoy reboots several times during the update and the LEDs light up in varied sequences until the update is complete. All four LEDs flash amber during boot up (approximately 3 minutes). When boot up is complete, the Device Communications LED  lights solid amber, indicating that devices are not yet detected. Once the update is finished and the PV system is installed, you are ready for Installation Part 2.
- Close the Three-Phase NPR cover and **lock it with padlocks**.

INSTALLATION – Part 2

You must complete Installation Part 2 after installing the Enphase IQ Microinverters.

7 Detect Devices

- Turn on the DG breaker(s).
- Unlock and open the Three-Phase NPR cabinet.
- Use one of the following methods to detect devices (Enphase IQ Microinverters and/or Enphase batteries):

Method A: Provision devices with Installer Toolkit

Use the Installer Toolkit mobile app to configure the IQ Envoy with the serial numbers of the installed devices.

- Launch the Installer Toolkit app and tap **View Systems**.
- Select the system you are working with, or tap **[+]** to add a system.
- Connect to the IQ Envoy with your mobile device (smart phone or tablet). The AP Mode LED  lights solid green when the network is available.
 - On the Envoy, if the AP Mode LED is not lit, press the **AP Mode** button.
 - On your mobile device, go to Settings and join the Wi-Fi network "Envoy_nnnnnn" (where "nnnnnn" equals the final six digits of the IQ Envoy serial number).
- If the serial number for the Envoy you are installing is not displayed on the System Overview screen, tap the **[+]** next to the word "Envoys". When the app displays the serial number of the Envoy, tap it to add it to the system.
- Following the on-screen instructions to create the arrays and scan the serial numbers from the installation map.
- Tap the **Connect** button. This provisions the scanned devices on the Envoy.
- When prompted, confirm the number of devices that you installed.
- If your system is in Hawaii or in a region that does not use the **Factory-Installed Grid Profile**, select and apply a grid profile to the devices.

The Device Communications LED  lights solid green if all provisioned devices are communicating or solid amber if any devices are not communicating.

Method B: Discover devices with Installer Toolkit

Use the Installer Toolkit mobile app to set the number of devices the IQ Envoy should search for on the power line.

- Connect to the IQ Envoy with your mobile device (smart phone or tablet). The AP Mode LED  lights solid green when the network is available.
 - On the Envoy, if the AP Mode LED is not lit, press the AP Mode button.
 - On your mobile device, go to Settings and join the Wi-Fi network "Envoy_nnnnnn" (where "nnnnnn" equals the final six digits of the IQ Envoy serial number).
- Launch Installer Toolkit and tap **Connect to an Envoy**.
- When prompted, enter the number of devices that you installed.
- If your system is in Hawaii or in region that does not use the **Factory-Installed Grid Profile**, select and apply a grid profile to the devices.
- When prompted to start a device scan, tap **OK**.

The Device Communications LED  flashes green while scanning, solid green when all the devices you installed are communicating, or solid amber if any devices are not communicating.

With both methods

If the Device Communications LED  remains solid amber, see *Troubleshooting* **b**.

8 Verify System Configuration



While still connected to the IQ Envoy with Installer Toolkit, check the Overview screen for the following:

- Confirm that the expected number of devices are detected and communicating.
- Check that the new profile is set on all the devices. Setting the profile may take up to 5 minutes for a typical system.
- Tap the **Meters** button.
- Tap **Production Meter** and follow the on-screen instructions to enable the Production Meter.
- If you installed consumption metering CT(s), tap **Consumption Meter** and follow the on-screen instructions to enable the Consumption Meter.
- Return to the **Overview** screen and verify the meter reading(s).

If you used Installer Toolkit to detect devices, the Power Production LED  lights solid green when all **expected** microinverters are producing power. If you did not use Installer Toolkit, it lights solid green if all **communicating** microinverters are producing power. It flashes green when devices are upgrading. Check Installer Toolkit for production status details. If the Power Production LED remains solid amber, see *Troubleshooting* **c**.

IQ Envoy display and controls

Track system installation progress with the **Enphase Installer Toolkit** mobile app. The LEDs on the IQ Envoy PCB (printed circuit board) are solid green when a function is enabled or performing as expected, flashing when an operation is in progress, or solid amber when troubleshooting with Installer Toolkit is required. For a legend of all LED states, see *Troubleshooting* **a**.

  — **Network Communications LED**
Green when IQ Envoy is connected to Enlighten.

  — **AP Mode LED**
Green when IQ Envoy's AP Wi-Fi network is available.

 — **AP Mode Button**
Press to enable IQ Envoy's AP Mode for connecting with a mobile device. Hold for 5 seconds to start WPS connection to a router.

  — **Power Production LED**
Green when microinverters are producing power.

  — **Device Communications LED**
Green when devices are communicating with IQ Envoy.

 — **Device Scan Button**
Press to start/stop 15 minute scan for devices over the power line.



Enphase Installer Toolkit mobile app

9 Connect to Enlighten Over Cellular

The Three Phase NPR includes a cell modem and data plan. The Enphase Mobile Connect LTE-M cell modem connects to AT&T's LTE-M cellular network. Refer to AT&T's LTE coverage maps, if needed.





Warning! If you have already installed and connected the cellular modem to the Envoy, do NOT move the modem to another Envoy. This will deactivate the modem.

- A) Confirm that the USB cable between IQ Envoy and the cell modem is connected at both ends. Use either of the two USB ports on the IQ Envoy.

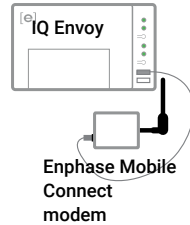
- If receiving power from the IQ Envoy, the modem power LED lights.
- Within three minutes the Network Communications LED  lights solid green, indicating a successful connection to Enlighten.
- If the Network Communications LED remains off or lights solid amber, see Troubleshooting in the *Enphase Mobile Connect Installation Guide*.



- B) Check the connection status and cellular signal strength:
- An Envoy with Mobile Connect automatically reports to Enlighten. When the Envoy establishes an Internet connection through the cellular modem, the Envoy Network Communications LED  lights solid green.
 - You can use the Enphase Installer Toolkit to check the modem status and cellular signal strength. The Envoy's AP (Access Point) Wi-Fi network allows you to connect your mobile device (smart phone or tablet) to the IQ Envoy.
- C) On the Envoy, the AP Mode LED  lights solid green when the network is available. If the AP Mode LED is not lit, press the **AP Mode** button.
- D) On your mobile device, go to **Settings** and join the Wi-Fi network "Envoy_nnnnnn" (where "nnnnn" represents the final six digits of the IQ Envoy serial number).
- E) Launch Installer Toolkit and tap **Connect to Envoy**.
- F) Tap **Network**.
- G) Under **Network Configuration**, tap **Cellular**. The app displays Connection Status and an indication of signal strength.
- H) Check the connection status and verify that signal strength is at least two bars for adequate data transmission.
- I) Close the Three-Phase NPR cabinet and **lock it with padlocks**.

10 Connect to Enlighten over Wi-Fi (optional)

To configure Wi-Fi, the cellular modem must not be connected. To use Wi-Fi, you need a wireless router with an Internet connection.

- A) On the Envoy, verify that no Ethernet cable is plugged into the RJ45 port.
- B) On the Envoy, verify that no cellular modem is plugged into the USB port.
- C) If the router supports WPS, press and hold the WPS button on the wireless router for a few seconds. On most routers, a WPS indicator begins flashing.
- D) If you are using the Installer Toolkit mobile app, tap the Network button, tap Wi-Fi, and then tap your network from the list of available networks. If the wireless router does not support WPS, you may be prompted to enter a password.



The Network Communications LED begins flashing green. Within three minutes the same LED lights solid green, indicating a successful connection to Enlighten. If the Network Communications LED remains off or lights solid amber, see Troubleshooting.

- E) Close the Three-Phase NPR cover and **lock it**.

11 Send System Summary Report

When you have completed your system setup, you can generate and email a summary report.

- A) From Installer Toolkit, tap **Done** in the upper-right corner of the screen to disconnect from the Envoy. Installer Toolkit will ask if you want to view a summary report.
- B) Tap **View Report**. The report displays IQ Envoy and system information with a list of device serial numbers, their last power reports, and information about the grid profile applied to the microinverters.
- C) Tap  to email the report to your office as a record of successful system installation or to the utility for evidence of grid profile settings.

12 Activate Monitoring

Register the IQ Envoy in Enlighten (enlighten.enphaseenergy.com). Then use one of the following methods to activate system monitoring in Enphase Enlighten.

Method A: If the IQ Envoy IS associated with a system in Installer Toolkit

- A) On your mobile device, go to Settings and disconnect from the Envoy's AP Wi-Fi network.
- B) Return to the Installer Toolkit app and tap the **Sync** button on the System Overview screen.
- C) When you have access to a computer, log in to Enlighten and select the system name from the Activation List on the dashboard.
- D) From the activation form, open Array Builder.

If you used Installer Toolkit to build arrays and scan device serial numbers, the array(s) are built. Make any necessary adjustments in Array Builder.

If you did NOT use Installer Toolkit to build arrays and scan device serial numbers, create the virtual array in Array Builder using the installation map as your reference.





Method B: If the IQ Envoy is NOT associated with a system in Installer Toolkit

- A) Log into Enlighten and click **Add a New System** from the dashboard.
- B) Enter the System, Installer, Owner, and Location information.
- C) Enter the IQ Envoy serial number.
- D) Click **Save** to submit the form.
- E) After the devices have reported to Enlighten, open Array Builder from the activation form, and create the virtual array, using the installation map as your reference.

TROUBLESHOOTING

Contact Enphase Customer Support (enphase.com/en-us/support/contact) if you have any questions about troubleshooting your system.

a IQ Envoy LED overview

LED	State	Description
All	Flashing amber	The IQ Envoy is booting up
	Flashing green sequentially	Software upgrade in progress
 Network communications	Solid green	Communicating with Enlighten
	Flashing green	WPS connection in progress, or IQ Envoy is attempting to connect to Enlighten
	Solid amber	Local network connection only
	Off	No network connection
 AP mode	Solid green	AP mode enabled: IQ Envoy Wi-Fi network available
	Off	AP mode disabled: IQ Envoy Wi-Fi network unavailable
 Power production	Solid green	All communicating microinverters are producing
	Flashing green	Microinverter upgrade in progress
	Solid amber	At least one microinverter is not producing
	Off	Microinverters are not communicating (low light or night time)
 Device communications	Solid green	All devices are communicating
	Flashing green	Device scan in progress
	Solid amber	At least one device is not communicating
	Off	Devices are not communicating (low light or night time)

b Device detection issues

If the Device Communications LED  lights solid amber, it may be a result of low light levels. If there isn't enough sunlight to power up the microinverters, they can't communicate with the Envoy.

If there is sufficient daylight for the microinverters to power up, the issue may be that the Envoy is having difficulty communicating over the power lines. To troubleshoot this issue:

- Check the Installer Toolkit mobile app to see which devices are not communicating.
- Check that the circuit breaker(s) in the Three Phase NPR for the PV array are in the "ON" position.
- Verify that the PV modules are connected to the microinverters.
- Verify the PV module DC voltage is within the allowable range for the microinverter.

c Power production issues

If the Power Production LED  lights solid amber, check the Installer Toolkit mobile app to see which microinverters are not producing:

- If none of the microinverters are producing power, there may be a grid or wiring issue. First, verify that there is proper input voltage and frequency from the utility. Next, check the breaker and wiring, starting at the load center.
- If all of the non-productive microinverters are on the same branch, check the breaker and wiring starting at the junction box for the affected branch.
- If only one or scattered microinverters are not producing power, first check to see that the AC connectors are fully seated. Next, check that each module is providing the required startup voltage for the microinverter (22V). A PV module that is failing or that is undersized may not generate enough power for AC conversion.

d Internet connection issues

If you are using Wi-Fi and the Network Communications LED  remains off or solid amber:

- The WPS connection window may have timed out. Retry the connection steps.
- Make sure that the broadband router is connected and operational by checking that other devices at the site can access the network.
- Be aware that metal enclosures or obstructions impede wireless communication.
- If you don't see your router/access point in the list on the Envoy, or cannot maintain a connection, you may need to add a wireless repeater to extend the network range.

You can troubleshoot network issues with the Installer Toolkit mobile app by tapping the **Network** button, then **Diagnostic Tools**.

If you are using the Enphase Mobile Connect modem and the Network Communications LED remains off or lights solid amber, see Troubleshooting in the *Enphase Mobile Connect Installation Guide*.

If you replace your router, configure the IQ Envoy Wi-Fi settings for the new Wireless Network Name (SSID) and password, or use the WPS function described in Installation Step 10.

e Loss of AC to a single branch of microinverters

If a single branch of microinverters is not producing, it may indicate loss of AC to the branch.

- Use a multi-meter set to AC to test the breaker lugs. The result should be around 240 VAC.
- If not, switch the breaker off and on to reset.

f Inoperable IQ Envoy (all LEDs off)

If the IQ Envoy is not receiving power, all LEDs will be off.

- Use a multimeter set to AC to test line 1 on the Envoy breaker to the AC neutral busbar. The result should be around 120 VAC.

g Inoperable IQ Envoy and no AC to branch

If a branch of microinverters is not producing and the IQ Envoy LEDs are off:

- Test at the main lugs for L-L and L-N voltages. The results should be around 240 VAC and 120 VAC respectively. If not, there may be a problem with the wiring from the panel.

Checking the Mobile Connect Modem LEDs

The Enphase Mobile Connect modem has the following status LEDs

- Power
- LS
- Signal

The following tables list LED indicator status. The LEDs may be difficult to see if viewed from an angle. View the LEDs from directly ahead.





Power

LED	Indicates
Off	DC power not present
On	DC power present

LS (Link Status)

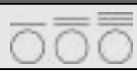
LED	Indicates
Lit solid	The modem is not registered on the cellular network.
Flashing	The modem is registered on the cellular network.

Signal

LEDs	Description	Indicates
	All off	Very weak signal
	LED 1 ON	Weak signal
	LED 1 and 2 ON	Good signal
	LED 1, 2, and 3 ON	Very good signal

Modem Troubleshooting

Issue	Action
No communication with Enlighten after connecting the cellular modem to the IQ Envoy.	<ol style="list-style-type: none"> 1. Disconnect the USB cable. 2. Power cycle the IQ Envoy. 3. Wait until the IQ Envoy boots up completely. 4. Reconnect the cellular modem USB cable.

Modem: Regulatory Notices

FCC - Antenna - Wireless Products only

The antenna intended for use with this unit meets the requirements for mobile operating configurations and for fixed mounted operations, as defined in 2.1091 and 1.1307 of the FCC rules for satisfying RF exposure compliance. If an alternate antenna is used, please consult user documentation for required antenna specifications.

FCC - 47 CFR Part 15 Regulation

This equipment has been tested and found to comply with the limits for a Class B digital device, pursuant to part 15 of the FCC Rules. These limits are designed to provide reasonable protection against harmful interference in a residential installation.

This equipment generates, uses, and can radiate radio frequency energy and, if not installed and used in accordance with the instructions, may cause harmful interference to radio communications. However, there is no guarantee that interference will not occur in a particular installation.

If this equipment does cause harmful interference to radio or television reception, which can be determined by turning the equipment off and on, the user is encouraged to try to correct the interference by one or more of the following measures:

- Reorient or relocate the receiving antenna.
- Increase the separation between the equipment and receiver.
- Connect the equipment into an outlet on a circuit different from that to which the receiver is connected.
- Consult the dealer or an experienced radio/TV technician for help.

This device complies with Part 15 of the 47 CFR rules. Operation of this device is subject to the following conditions: (1) This device may not cause harmful interference, and (2) this device must accept any interference that may cause undesired operation.

Industry Canada Class B Notice

This Class B digital apparatus meets all requirements of the Canadian Interference-Causing Equipment Regulations.

Cet appareil numérique de la classe B respecte toutes les exigences du Règlement Canadien sur le matériel brouilleur.

This device complies with Industry Canada RSS Appliance radio exempt from licensing. The operation is permitted for the following two conditions:

1. the device may not cause harmful interference, and
2. the user of the device must accept any interference suffered, even if the interference is likely to jeopardize the operation.

Le présent appareil est conforme aux CNR d'Industrie Canada applicables aux appareils radio exempts de licence.

L'exploitation est autorisée aux deux conditions suivantes:

1. l'appareil ne doit pas produire de brouillage, et
2. l'utilisateur de l'appareil doit accepter tout brouillage radioélectrique subi, même si le brouillage est susceptible d'en compromettre le fonctionnement.

Industry Canada and FCC

This device complies with Industry Canada license-exempt RSS standard(s) and part 15 of the FCC rules. Operation is subject to the following two conditions:

1. this device may not cause interference, and
2. this device must accept any interference, including interference that may cause undesired operation of the device.

Cet appareil est conforme avec Industrie Canada RSS exemptes de licence standard (s) et la partie 15 des règles de la FCC. Son fonctionnement est soumis aux deux conditions suivantes:

1. l'appareil ne doit pas produire de brouillage, et
2. l'utilisateur de l'appareil doit accepter tout brouillage radioélectrique subi, même si le brouillage est susceptible d'en compromettre le fonctionnement.

EMC, Safety, and R&TTE Directive Compliance

The CE mark is affixed to this product to confirm compliance with the following European Community Directives:

Council Directive 2004/108/EC of 15 December 2004 on the approximation of the laws of Member States relating to electromagnetic compatibility;

and

Council Directive 2006/95/EC of 12 December 2006 on the harmonization of the laws of Member States relating to electrical equipment designed for use within certain voltage limits;

and

Council Directive 2011/65/EU on the restriction of the use of certain hazardous substances in electrical and electronic equipment;

and

Council Directive 1999/5/EC of 9 March 1999 on radio equipment and telecommunications terminal equipment and the mutual recognition of their conformity.

SAFETY

IMPORTANT SAFETY INSTRUCTIONS. SAVE THESE INSTRUCTIONS.

Follow these instructions during installation and maintenance of the Three Phase NPR. If you do not fully understand the concepts, terminology, or hazards outlined in these instructions, refer installation to a qualified electrician or installer. These instructions are not meant to be a complete explanation of a renewable energy system.

Safety and Advisory Symbols

	DANGER: This indicates a hazardous situation, which if not avoided, will result in death or serious injury.
	WARNING: This indicates a situation where failure to follow instructions may be a safety hazard or cause equipment malfunction. Use extreme caution and follow instructions carefully.
	NOTE: This indicates information particularly important for optimal system operation. Follow instructions carefully.

Safety Instructions

	DANGER: Risk of electric shock. Risk of fire. Do not attempt to repair any non-serviceable parts of the Three Phase NPR. Doing so will void the warranty. For non-serviceable part repair, contact Enphase Customer Support for assistance (enphase.com/en-us/support/contact).
	DANGER: Risk of electric shock. Risk of fire. All serviceable components must be serviced or replaced only by properly trained and authorized personnel.
	DANGER: Risk of electrocution! Do not install CTs when current flowing in the sensed circuit. Always install CT wires in the terminal blocks before energizing the sensed circuit.
	DANGER: Risk of electric shock. Do not use Enphase equipment in a manner not specified by the manufacturer. Doing so may cause death or injury to persons, or damage to equipment.
	DANGER: Risk of electric shock. Be aware that installation of this equipment includes risk of electric shock. Do not install the Three Phase NPR without first removing AC power from the Enphase System. Ensure the power coming from the microinverters is de-energized before servicing or installing.
	DANGER: Risk of electric shock. Risk of fire. Only qualified personnel should troubleshoot, install, or replace the Three Phase NPR.
	DANGER: Risk of electric shock. Improper servicing of the Three Phase NPR or its components may result in a risk of shock, fire or explosion. To reduce these risks, disconnect all wiring before attempting any maintenance or cleaning.
	DANGER: Risk of electric shock. Always de-energize the AC branch circuit before servicing. While connectors are rated for disconnect under load, it is a best practice to de-energize before disconnecting.
	DANGER: Risk of electric shock. Risk of fire. Only use electrical system components approved for wet locations.
	DANGER: Risk of electric shock. Risk of fire. Ensure that all wiring is correct and that none of the wires are pinched or damaged.
	DANGER: Risk of electric shock. Risk of fire. Do not work alone. Someone should be in the range of your voice or close enough to come to your aid when you work with or near electrical equipment. Remove rings, bracelets, necklaces, watches etc. when working with batteries, photovoltaic modules or other electrical equipment.
	DANGER: Risk of electric shock. Risk of fire. Before making any connections verify that the circuit breaker(s) are in the off position. Double check all wiring before applying power.
	DANGER: Risk of electric shock. Risk of fire. Do not wire unused terminals or terminal blocks on the IQ Envoy.
	WARNING: Risk of electric shock. To maintain the warranty, do not modify the cover.
	WARNING: Before installing or using the Three Phase NPR, read all instructions and cautionary markings in the technical description and on the equipment.
	WARNING: Use the circuit breakers in the Enphase Three Phase NPR only for serving Enphase equipment. No other loads are allowed.

FCC Statement: This equipment has been tested and found to comply with the limits for a Class B digital device, pursuant to part 15 of the FCC Rules. These limits are designed to provide reasonable protection against harmful interference in a residential installation.

This equipment generates, uses and can radiate radio frequency energy and, if not installed and used in accordance with the instructions, may cause harmful interference to radio communications. However, there is no guarantee that interference will not occur in a particular installation.

If this equipment does cause harmful interference to radio or television reception, which can be determined by turning the equipment off and on, you are encouraged to try to correct the interference by one or more of the following measures:

- Reorient or relocate the receiving antenna.
- Increase the separation between the equipment and the receiver.
- Connect the equipment into an outlet on a circuit different from that to which the receiver is connected.
- Consult the dealer or an experienced radio/TV technician for help.

Changes or modifications not expressly approved by the party responsible for compliance may void the user's authority to operate the equipment.

This Class B digital apparatus complies with Industry Canada ICES-003.

	WARNING: This unit is not provided with a GFDI device. This inverter or charge controller must be used with an external GFDI device as required by the Article 690 of the National Electrical Code for the installation location.
	WARNING: This product is intended for operation in an environment having a maximum ambient temperature of 50°C (122°F).
	WARNING: BONDING BETWEEN CONDUIT CONNECTIONS IS NOT AUTOMATIC AND MUST BE PROVIDED AS PART OF THE INSTALLATION.
	NOTE: Perform all wiring in accordance with all applicable local electrical codes, with the Canadian Electrical Code, Part I, and with the National Electrical Code (NEC), ANSI/NFPA 70.
	NOTE: Protection against lightning and resulting voltage surge must be in accordance with local standards.
	NOTE: Using unapproved attachments or accessories could result in damage or injury.
	NOTE: Install the Three Phase NPR in the field with 90°C or higher copper conductors sized per local code requirements and voltage drop/rise considerations.
	NOTE: Use Class 1 wiring methods for field wiring connections to terminals of a Class 2 circuit. Use 14 to 6 AWG wire for branch circuits and 14 to 3 AWG for output circuits. Select the wire gauge used based on the protection provided by the circuit breaker(s)/fuses. Overcurrent protection must be installed as part of the system installation.
	NOTE: To ensure optimal reliability and to meet warranty requirements, the Enphase Three Phase NPR must be installed according to the instructions in this manual.



Warning! Changes or modifications to the Three-Phase Network Protection Relay or any of the components not expressly approved by the party responsible for compliance may void the user's authority to operate the equipment.