

Installation Manual

AUTOMATIC BACKUP UNIT

BUU_{xx}-US-10

SBS-ABU-_{xx}-US-10

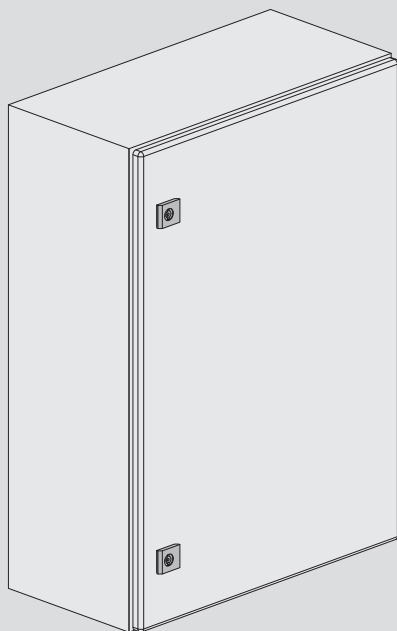

Legal Provisions

The information contained in these documents is the property of SMA Solar Technology America LLC. No part of this document may be reproduced, stored in a retrieval system, or transmitted, in any form or by any means, be it electronic, mechanical, photographic, magnetic or otherwise, without the prior written permission of SMA Solar Technology America LLC. Internal reproduction used solely for the purpose of product evaluation or other proper use is allowed and does not require prior approval.

SMA Solar Technology America LLC makes no representations or warranties, express or implied, with respect to this documentation or any of the equipment and/or software it may describe, including (with no limitation) any implied warranties of utility, merchantability, or fitness for any particular purpose. All such representations or warranties are expressly disclaimed. Neither SMA Solar Technology America LLC nor its distributors or dealers shall be liable for any indirect, incidental, or consequential damages under any circumstances.

The exclusion of implied warranties may not apply in all cases under some statutes, and thus the above exclusion may not apply.

Specifications are subject to change without notice. Every attempt has been made to make this document complete, accurate and up-to-date. Readers are cautioned, however, that product improvements and field usage experience may cause SMA Solar Technology America LLC to make changes to these specifications without advance notice, or per contract provisions in those cases where a supply agreement requires advance notice. SMA Solar Technology America LLC shall not be responsible for any damages, including indirect, incidental or consequential damages, caused by reliance on the material presented, including, but not limited to, omissions, typographical errors, arithmetical errors or listing errors in the content material.

Trademarks

All trademarks are recognized, even if not explicitly identified as such. Missing designations do not mean that a product or brand is not a registered trademark.

SMA Solar Technology AG

Sonnenallee 1

34266 Niestetal

Germany

Tel. +49 561 9522-0

Fax +49 561 9522-100

www.SMA.de

Email: info@SMA.de

Status: 10/15/2019

Copyright © 2018 SMA Solar Technology America LLC. All rights reserved.

Table of Contents

1	Information on this Document	4
1.1	Validity	4
1.2	Target Group	4
1.3	Levels of Warning Messages	4
1.4	Symbols in the Document	4
1.5	Typographies in the Document.....	5
1.6	Designation in the document	5
2	Safety	6
2.1	Intended Use	6
2.2	IMPORTANT SAFETY INSTRUCTIONS.....	6
3	Scope of Delivery	8
4	Product Overview	9
4.1	Product Description	9
4.2	Symbols on the Product	9
5	System Structure.....	11
6	Mounting.....	14
6.1	Requirements for Mounting	14
6.2	Mounting the product	16
7	Electrical Connection	17
7.1	Overview of the Connection Area	17
7.2	Inserting the Cables	18
7.3	Connecting the communication cable of the battery inverter.....	18
7.4	Connecting to utility grid and household distribution system	21
7.5	Connecting the power cables of the inverter	22
7.6	Connecting the energy meter (optional).....	23
8	Commissioning the battery-backup system	25
9	Compliance Information	26
10	Technical Data	27
10.1	SBS-ABU-50-US-10 / SBS-ABU-100-US-10 / SBS-ABU-200-US-10.....	27
10.2	General Data	28
11	Contact	29

1 Information on this Document

1.1 Validity

This document is valid for:

- SBS-ABU-50-US-10 / BUUS1-US-10
- SBS-ABU-100-US-10 / BUUM2-US-10
- SBS-ABU-200-US-10 / BUUM3-US-10

1.2 Target Group

The tasks described in this document must only be performed by qualified persons. Qualified persons must have the following skills:

- Training in how to deal with the dangers and risks associated with installing, repairing and using electrical devices and installations
- Training in the installation and commissioning of electrical devices and installations
- Knowledge of all applicable laws, standards and directives
- Knowledge of and compliance with this document and all safety information

1.3 Levels of Warning Messages

The following levels of warning messages may occur when handling the product.

⚠ DANGER
Indicates a hazardous situation which, if not avoided, will result in death or serious injury.
⚠ WARNING
Indicates a hazardous situation which, if not avoided, could result in death or serious injury.
⚠ CAUTION
Indicates a hazardous situation which, if not avoided, could result in minor or moderate injury.
NOTICE
Indicates a situation which, if not avoided, can result in property damage.

1.4 Symbols in the Document

Symbol	Explanation
	Information that is important for a specific topic or goal, but is not safety-relevant
<input type="checkbox"/>	Indicates a requirement for meeting a specific goal
<input checked="" type="checkbox"/>	Desired result

Symbol	Explanation
✘	A problem that might occur
	Example

1.5 Typographies in the Document

Typography	Use	Example
bold	<ul style="list-style-type: none"> • Messages • Terminals • Elements on a user interface • Elements to be selected • Elements to be entered 	<ul style="list-style-type: none"> • Connect the insulated conductors to the terminals X703:1 to X703:6. • Enter 10 in the field Minutes.
>	<ul style="list-style-type: none"> • Connects several elements to be selected 	<ul style="list-style-type: none"> • Select Settings > Date.
[Button] [Key]	<ul style="list-style-type: none"> • Button or key to be selected or pressed 	<ul style="list-style-type: none"> • Select [Enter].

1.6 Designation in the document

Complete designation	Designation in this document
Automatic Backup Unit	Automatic transfer switch, product
SMA Solar Technology America LLC	SMA
SMA Solar Technology Canada Inc.	SMA

2 Safety

2.1 Intended Use

The Automatic Backup Unit is an optional accessory for the Sunny Boy Storage inverter. It contains an automatic transfer switch, SMA Backup Unit Controller, overcurrent protection for the inverter(s) and optionally an integrated energy meter and current transformers. In the event of grid failure, the Automatic Backup Unit disconnects the PV system, loads and the Sunny Boy Storage from the utility grid and creates a battery-backup grid. The battery-backup grid supplies loads that should continue to be supplied with electricity in the event of grid failure. In the event of grid failure, the Sunny Boy Storage supplies the loads with energy after a short switching time. The PV system supplies additional energy that can be used to supply the loads and charge the battery.

The product is certified for use with the following SMA inverters:

- SBS3.8-US-10 / SBS5.0-US-10 / SBS6.0-US-10

Use of the product with battery inverters of manufacturers other than SMA is not permitted.

The product is suitable for indoor and outdoor use.

The product is not suitable for supplying life-sustaining medical devices. A power outage must not lead to personal injury.

All components must remain within their permitted operating ranges and their installation requirements at all times.

The product is approved for the US and Canadian market.

The product may only be operated with one of the energy meters approved by SMA Solar Technology AG. The following energy meters are allowed to be used when operating this product:

Use SMA products only in accordance with the information provided in the enclosed documentation and with the locally applicable laws, regulations, standards and directives. Any other application may cause personal injury or property damage.

Alterations to the SMA products, e.g., changes or modifications, are only permitted with the express written permission of SMA Solar Technology AG. Unauthorized alterations will void guarantee and warranty claims and in most cases terminate the operating license. SMA Solar Technology AG shall not be held liable for any damage caused by such changes.

Any use of the product other than that described in the Intended Use section does not qualify as the intended use.

The enclosed documentation is an integral part of this product. Keep the documentation in a convenient, dry place for future reference and observe all instructions contained therein.

This document does not replace and is not intended to replace any local, state, provincial, federal or national laws, regulations or codes applicable to the installation, electrical safety and use of the product. SMA Solar Technology AG assumes no responsibility for the compliance or non-compliance with such laws or codes in connection with the installation of the product.

The type label must remain permanently attached to the product.

2.2 IMPORTANT SAFETY INSTRUCTIONS

SAVE THESE INSTRUCTIONS

This section contains safety information that must be observed at all times when working on or with the product.

The product has been designed and tested in accordance with international safety requirements. As with all electrical or electronic devices, there are residual risks despite careful construction. To prevent personal injury and property damage and to ensure long-term operation of the product, read this section carefully and observe all safety information at all times.

DANGER

Danger to life due to electric shock when live components or cables are touched

High voltages are present in the conductive components or cables of the product. Touching live parts and cables results in death or lethal injuries due to electric shock.

- Do not touch non-insulated parts or cables.
- Disconnect the system from voltage sources and make sure it cannot be reconnected before working on the device.
- Wear suitable personal protective equipment for all work on the product.

NOTICE

Damage to the product due to sand, dust and moisture ingress

Sand, dust and moisture penetration can damage the product and impair its functionality.

- Only open the product if the humidity is within the thresholds and the environment is free of sand and dust.
- Do not open the product during a dust storm or precipitation.
- The product must only be closed during operation.

Electrical installations (for North America)

All installations must conform with the laws, regulations, codes and standards applicable in the jurisdiction of installation (e.g. *National Electrical Code*® ANSI/NFPA 70 or *Canadian Electrical Code*® CSA-C22.1.).

- Before connecting the inverter to the utility grid, contact your local grid operator. The electrical connection of the inverter must be carried out by qualified persons only.
- Ensure that the cables or conductors used for electrical connection are not damaged.

3 Scope of Delivery

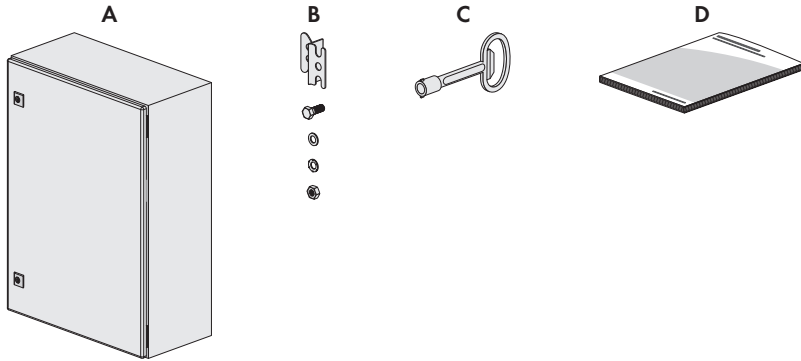

Figure 1: Components included in the scope of delivery

Position	Number	Designation
A	1	Automatic Backup Unit
B	4	Wall mounting bracket incl. mounting material
C	1	Switch cabinet key
D	1	Installation Manual

4 Product Overview

4.1 Product Description

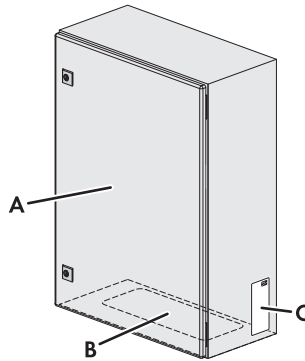





Figure 2: Design of the Product

Position	Designation
A	Enclosure door
B	Connecting plate
C	Type label The type label clearly identifies the product. The type label must remain permanently attached to the product. You will find the following information on the type label: <ul style="list-style-type: none"> • Information of the manufacturer • Device type (Model) • Serial number (Serial No. or S/N) • Date of manufacture • Device-specific characteristics and designations

4.2 Symbols on the Product

Symbol	Explanation
	Beware of electrical voltage The product operates at high voltages.
	Beware of hot surface The product can get hot during operation.

Symbol	Explanation
	<p>Observe the documentation</p> <p>Observe all documentation supplied with the product.</p>
	<p>UL 1741 and CSA C22.2 No. 107.1 are the standards applied by Underwriters Laboratories to the product to certify that it meets the requirements of the <i>National Electrical Code</i>[®], the <i>Canadian Electrical Code</i>[®] and IEEE 1547.</p>

5 System Structure

The system consisting of battery inverters, PV inverters and an automatic transfer switch must be set up in accordance with the following schematic diagram. At the same time, the local regulations and standards must be observed.

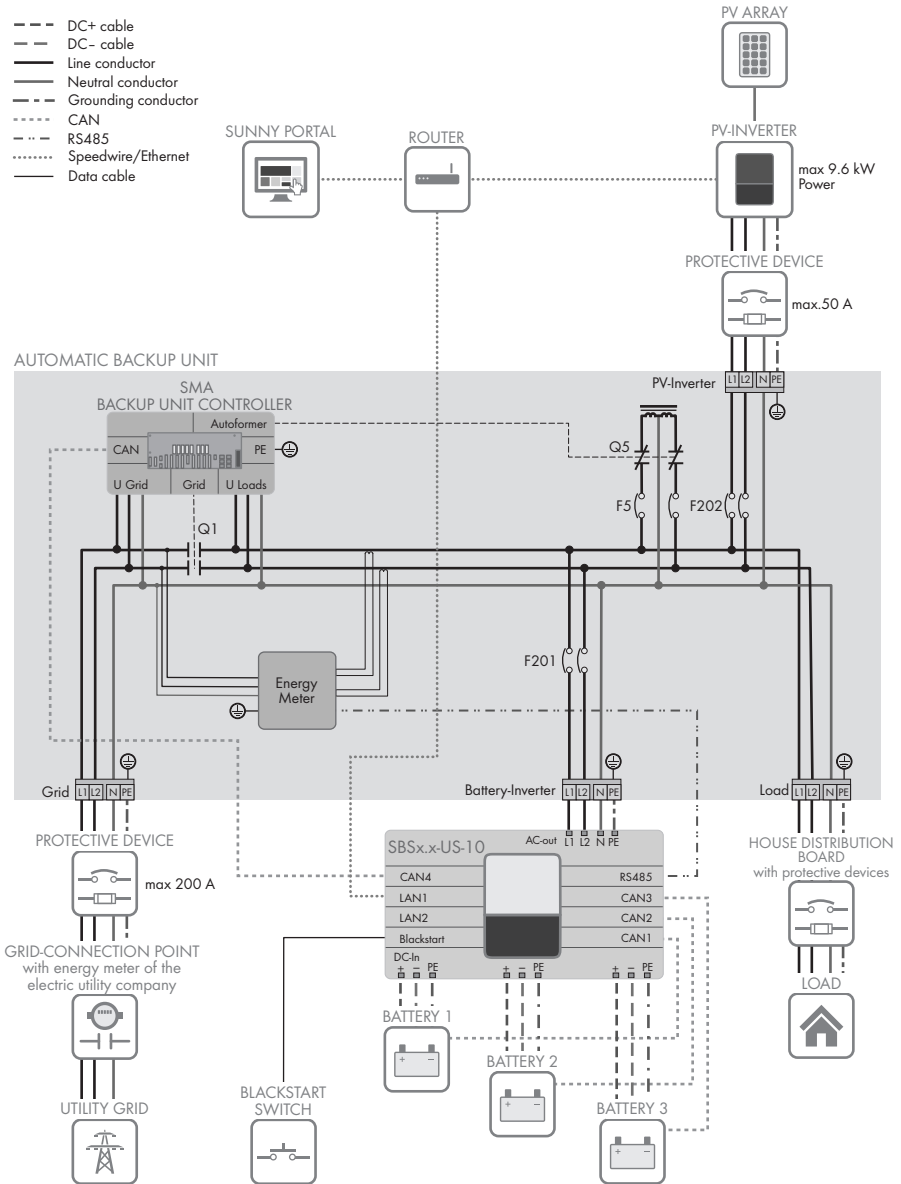

Figure 3: System overview of the battery-backup system with Sunny Boy Storage

Delivery of overload current

- During ramp-up: delivery of overload current for a maximum of one minute. Thereafter, the inverter shuts down.
- During operation: overload current for a maximum of 500 ms. Thereafter, the inverter shuts down.
- Automatic restart after shutdown: maximum of three reconnect attempts
- Waiting time between each reconnect attempt: 90 s

Measures for guaranteeing the fail-safe operation in the battery inverter

- Insulation monitoring of the battery voltage
- Monitoring of the N-PE terminal of the battery inverter
- Redundant grid disconnection relays in the battery inverter

6 Mounting

6.1 Requirements for Mounting

⚠ WARNING

Danger to life due to fire or explosion

Despite careful construction, electrical devices can cause fires.

- Do not mount the product in areas containing highly flammable materials or gases.
- Do not mount the product in potentially explosive atmospheres.

Mounting location:

- A solid, flat support surface must be available for mounting.
- The mounting location must be suitable for the weight and dimensions of the product (see Section 10 "Technical Data", page 27).
- The mounting location should be freely and safely accessible at all times without the need for any auxiliary equipment (such as scaffolding or lifting platforms). Non-fulfilment of these criteria may restrict servicing.
- The mounting location must not hinder access to disconnection devices.
- The mounting location must not be exposed to direct solar irradiation. Direct solar irradiation can cause the product to overheat.
- All ambient conditions must be met (see Section 10, page 27).
- The product may only be mounted in a permitted mounting position.

Permitted und prohibited mounting position:

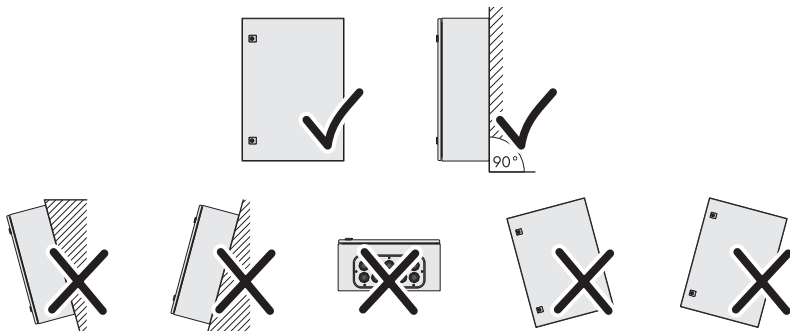

Figure 4: Permitted and prohibited mounting positions

Dimensions for mounting:

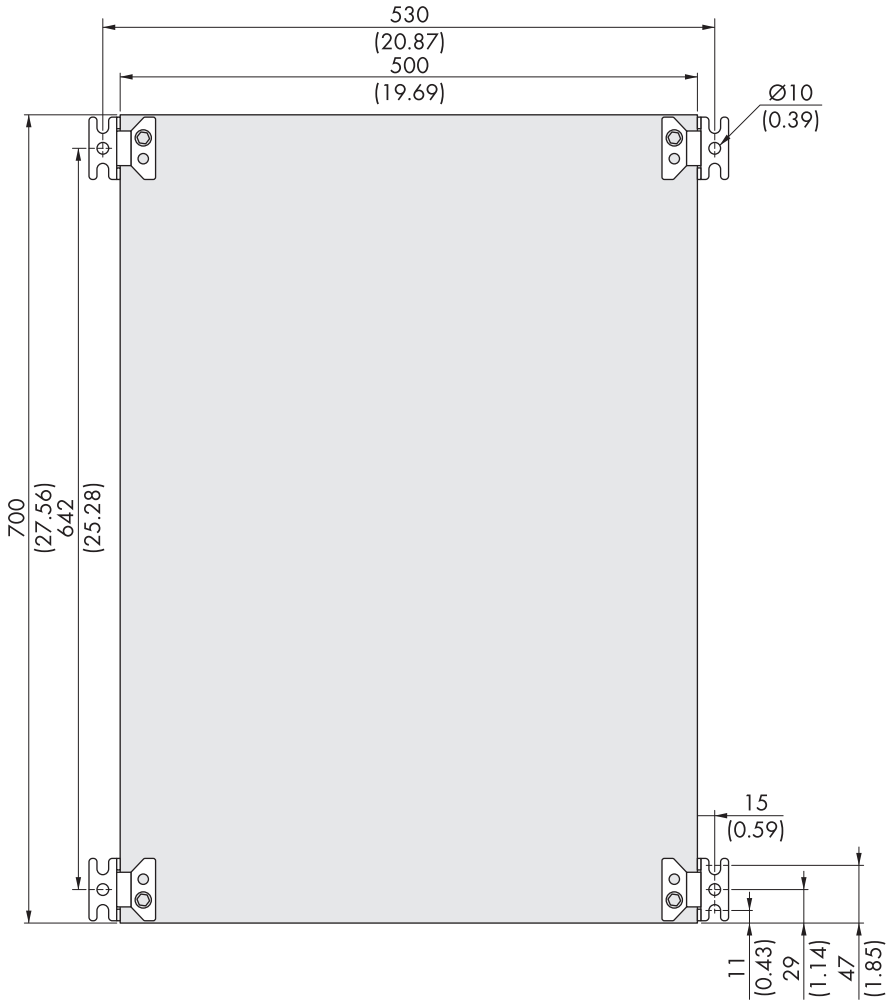

Figure 5: Dimensions of the product(Dimensions in mm (in))

6.2 Mounting the product

⚠ CAUTION

Risk of injury due to weight of product

Injuries may result if the product is lifted incorrectly or dropped while being transported or when attaching it to or removing it from the wall mounting bracket.

- Transport and lift the product carefully. Take the weight of the product into account.
- Wear suitable personal protective equipment for all work on the product.

Additionally required mounting material (not included in the scope of delivery):

- Four screws, washers and fastening material suitable for the support surface

Procedure:

1. Attach the wall mounting bracket to the enclosure using fastening material, torque: 10 Nm to 15 Nm (88.5 in-lb to 133 in-lb).

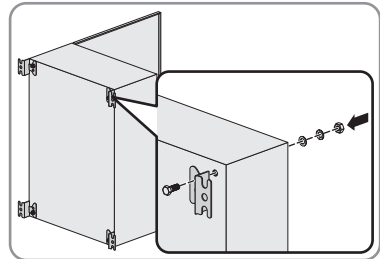

2. Mark the position of the four drill holes and drill the holes (diameter: 10 mm (0.39 in)).
3. Attach the product to the wall using four suitable screws, washers and fastening material.

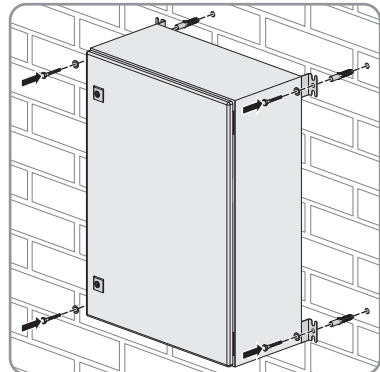

4. Ensure that the product is securely in place.

7 Electrical Connection

7.1 Overview of the Connection Area

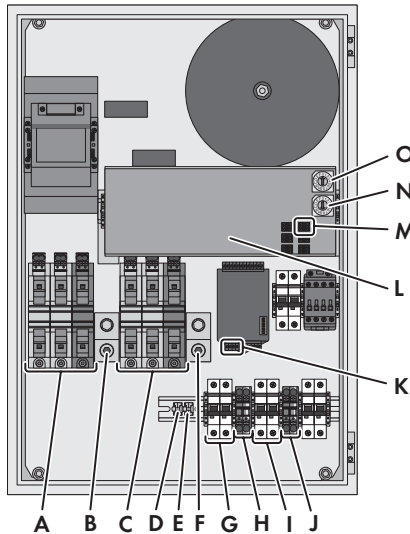

Figure 6: Connection areas in the interior of the product

Position	Designation
A	Terminal blocks -X200 for connection to the utility grid
B	Equipment grounding terminal for the equipment grounding conductor of the utility grid
C	Terminal blocks -X206 for connection to the household distribution system
D	Shield connection terminal for communication cables of the battery inverter
E	Shield connection terminal for the communication cable of the energy meter
F	Equipment grounding terminal for the equipment grounding conductor of the household distribution system
G	Circuit breaker -F202 for connecting the power cables of the PV inverter(s)
H	Terminal blocks for the neutral conductor and equipment grounding conductor of the battery inverter
I	Circuit breaker -F201 for connecting the power cables of the battery inverter(s)
J	Terminal blocks for the neutral conductor and equipment grounding conductor of the PV inverter
K	Terminal blocks for connecting the communication cable of the energy meter

Position	Designation
L	Backup Unit Controller
M	Jack for connecting the communication cable to the battery inverter
N	The rotary switch S2100 on the SMA Backup Unit Controller
O	The rotary switch S2101 on the SMA Backup Unit Controller.

7.2 Inserting the Cables

Always insert the cables into the product according to the following procedure.

Additionally required material (not included in the scope of delivery):

- Conduits
- Listed rain-tight conduit fittings for wet locations

Procedure:

1. Ensure that the cables are voltage-free.
2. Open the product using the switch cabinet key.
3. Unscrew the seven screws of the dead front using a flat-blade screwdriver (blade width: 5 mm (0.2 in)) and then remove it.
4. Cut openings into the connection plate on the bottom of the enclosure.
5. Insert the conduit fitting into the opening and tighten from the inside using the counter nut.
6. Attach the conduit to the conduit fitting.
7. Guide the conductors from the conduit into the product.
8. Ensure that the amount of conductor inserted is of a sufficient length for the selected terminal block.

7.3 Connecting the communication cable of the battery inverter

Additionally required material (not included in the scope of delivery):

- One communication cable between inverter and automatic transfer switch
- If cables are used for outdoors: one waterproof cable gland

Requirement for the communication cable:

- Twisted pair conductors
- Cable category: minimum CAT5e
- Shielding: yes
- Conductor cross-section: 0.25 mm² to 0.34 mm² (24 AWG to 16 AWG)
- Recommended number of conductor pairs: 4
- External diameter: 6 mm to 8.5 mm (0.24 in to 0.33 in)
- Maximum cable length between battery and inverter and, in battery-backup systems, between automatic transfer switch and inverter: 10 m (33 ft)
- UV-resistant for outdoor use.

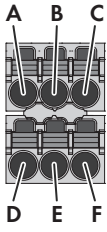
Terminal block	Position	Assignment
	A	Not assigned
	B	Enable
	C	GND
	D	CAN L
	E	CAN H
	F	+12V supply for automatic transfer switching device

Procedure:

1. Insert the communication cable (see Section 7.2, page 18).
2. Strip the communication cable 130 mm (5.12 in).
3. Trim the cable shield to a length of 20 mm (0.79 in) and fold it over the cable sheath.

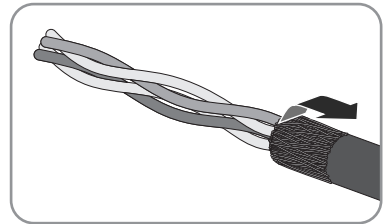

4. Strip the insulation on the insulated conductors each by 6 mm (0.24 in). The **CAN L** and **CAN H** must be a twisted pair.
5. If necessary, trim unused insulated conductors flush with the cable sheath or fold it over the cable sheath.

6. Connect the conductors of the communication cables to the 6-pole terminal block. Pay attention to the assignment of the terminal block and communication connection on the battery inverter and make sure that **CAN L** and **CAN H** consist of a pair of conductors.

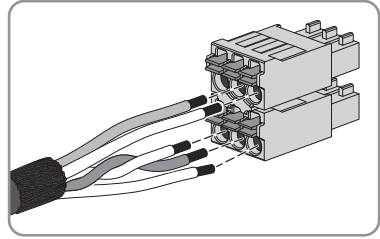

7. Ensure that the conductors are plugged into the terminal points tightly by pulling slightly on the conductors.
8. Insert the terminal block for the communication connection into the jack **X2504** on the Backup Unit Controller.

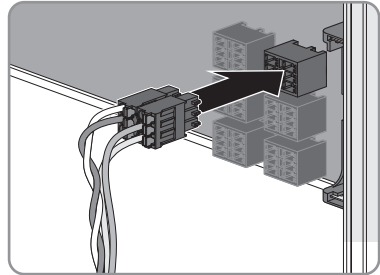

9. Connect the communication cable with cable shield to the shield connection terminal. In this process, press down the shield connection terminal using a flat-blade screwdriver (blade width: max. 10 mm (3/8 in)) and insert the cable shield of the communication cable from the side.

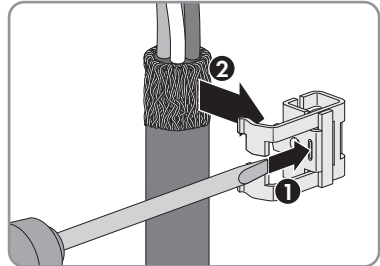

10. Ensure that the rotary switch **S2101** of the SMA Backup Unit Controller is on position **0** and the rotary switch **S2100** of the SMA Backup Unit Controller is on position **8**.

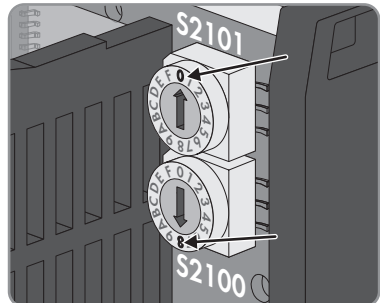

7.4 Connecting to utility grid and household distribution system

Requirements:

- All electrical installations must be carried out in accordance with the local standards and the *National Electrical Code*® ANSI/NFPA 70 or the *Canadian Electrical Code*® CSA C22.1.
- The AC and DC electric circuits are isolated from the enclosure. If required by the *National Electrical Code*® ANSI/NFPA 70 or *Canadian Electrical Code*® CSA C22.1, the installer is responsible for grounding the system.
- The connection requirements of the grid operator must be met.
- The grid voltage must be within the permissible range.

Requirements on the AC conductors:

- The maximum permitted temperature for the terminal block of the AC connection of 105°C (221 °F) must be observed.
- Maximum permissible conductor temperature class: 75°C (+167°F) and 90°C (194°F)
- The conductors with regards to its ampacity, rated temperatures, operating conditions and its power loss must be made in accordance with the local standards and the *National Electrical Code*® ANSI/NFPA 70 or the *Canadian Electrical Code*® CSA C22.1.
- Conductor type: copper wire
- The conductors must be made of solid wire, stranded wire or fine stranded wire. When using fine stranded wire, bootlace ferrules must be used.

Procedure:

1. Insert the cables (see Section 7.2, page 18).
2. Connect to the utility grid and household distribution system by attaching the equipment grounding conductors to the respective equipment grounding terminals:

- Strip the insulation of the equipment grounding conductor by 29 mm (1.14 in).
- Put the equipment grounding conductor of the utility grid into the equipment grounding terminal **PE** on the right side of the **-X200** and tighten it using an Allen key (torque: 31 Nm (274 in-lb)).

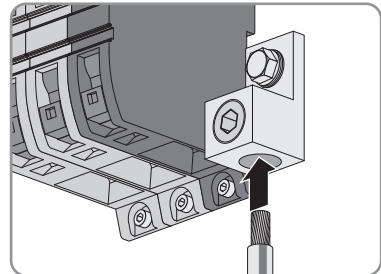

- Put the equipment grounding conductor of the household distribution system into the equipment grounding terminal **PE** on the right side of the **-X206** and tighten it using an Allen key (torque: 31 Nm (274 in-lb)).
- Make sure that each equipment grounding conductor is securely in place in the equipment grounding terminal.

3. Strip off the conductor insulation of L1, L2 and N (see Section 10 "Technical Data", page 27).
4. Connect the conductors L1, L2 and N of the utility grid to the terminal block **-X200** in accordance with the labeling. Insert and press down the screwdriver into the square-shaped opening of the terminal block.

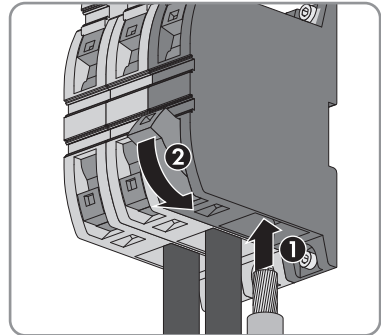

5. Connect the conductors L1, L2 and N of the household distribution system to the terminal block **-X206** in accordance with the labeling. For each, use a screwdriver to depress and open the terminal, then insert the stripped conductor.
6. Ensure that the conductors sit securely in the terminal point of the terminal block.

7.5 Connecting the power cables of the inverter

Requirements on the AC conductors:

- Maximum permissible conductor temperature class: 75°C (+167°F) and 90°C (194°F)
- The conductors with regards to its ampacity, rated temperatures, operating conditions and its power loss must be made in accordance with the local standards and the *National Electrical Code*® ANSI/NFPA 70 or the *Canadian Electrical Code*® CSA C22.1.
- Conductor type: copper wire
- The conductors must be made of solid wire, stranded wire or fine stranded wire. When using fine stranded wire, bootlace ferrules must be used.

Procedure:

1. Insert the cables (see Section 7.2, page 18).
2. Strip off the conductor insulation of N and PE by 18 mm (0.71 in).
3. Connect the conductor N and the equipment grounding conductor of the battery inverter to the terminal blocks on the right side of the circuit breaker **-F201** in accordance with the color coding. Insert each conductor into the corresponding terminal point (round opening) up to the stop.

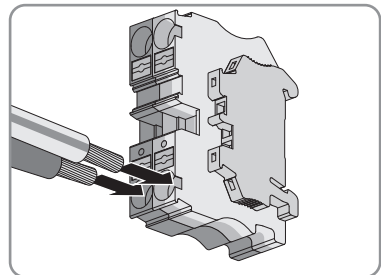

4. Connect the conductor N and the equipment grounding conductor of the PV inverter to the terminal blocks on the right side of the circuit breaker -**F202** in accordance with the color coding. Insert each conductor into the corresponding terminal point (round opening) up to the stop.
5. Strip off the conductor insulation of L1 and L2 by 14.1 mm (9/16 in) each.
6. Connect the conductors L1 and L2 of the battery inverter to the terminal blocks of the circuit breaker -**F201**. To do so, insert each conductor into the respective terminal point (round opening) and tighten it using a flat-blade screwdriver (blade width: 8 mm (5/16 in); torque: 2.8 Nm (24.8 in-lb)).

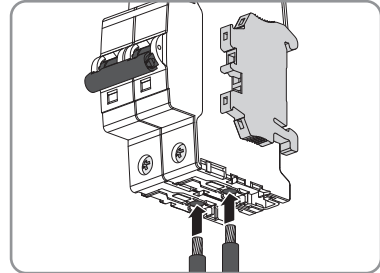

7. Connect the conductors L1 and L2 of the PV inverter to the terminal block of the circuit breaker -**F202**. To do so, insert each conductor into the respective terminal point (round opening) and tighten it using a flat-blade screwdriver (blade width: 8 mm (5/16 in); torque: 2.8 Nm (24.8 in-lb)).
8. Ensure that the conductors sit securely in the terminal point of the terminal block.

7.6 Connecting the energy meter (optional)

When the product is equipped with an energy meter, connect the energy meter as described in the following.

Additionally required material (not included in the scope of delivery):

- One communication cable

Cable requirements:

- Cross-section: at least 2 x 2 x 0.22 mm² (2 x 2 x 24 AWG)
- Shielding: yes
- Twisted pair conductors
- UV-resistant for outdoor use.
- Maximum cable length: 10 m (33 ft)

Assignment of the terminal block:

Plug	Position	Assignment
	A-	Data+ (D+)
	B+	Data- (D-)
	C	Ground (GND)
	X	Not assigned

Procedure:

1. Insert the communication cable (see Section 7.2, page 18).
2. Strip the communication cable 130 mm (5.12 in).
3. Trim the cable shield to a length of 20 mm (0.79 in) and fold it over the cable sheath.

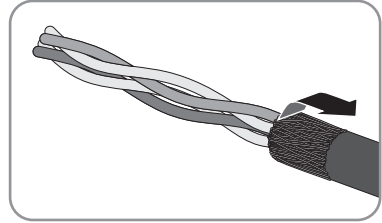

4. Strip the insulation on the insulated conductors each by 6 mm (0.24 in).
5. If necessary, trim unused insulated conductors flush with the cable sheath or fold it over the cable sheath.
6. Insert the conductors into the terminal blocks in accordance with the assignment and tighten it using a screwdriver.

Assignment of the energy meter	Assignment of the inverter
A+ - Data+ (D+)	2 - Data+ (D+)
B+ - Data- (D-)	7 - Data- (D-)
C - Ground (GND)	5 - Ground (GND)

7. Ensure that the conductors are plugged into the terminal points tightly by pulling slightly on the conductors.
8. Connect the communication cable with cable shield to the shield connection terminal. In this process, press down the shield connection terminal using a screwdriver (blade width: max. 10 mm (3/8 in)) and insert the cable shield of the communication cable from the side.

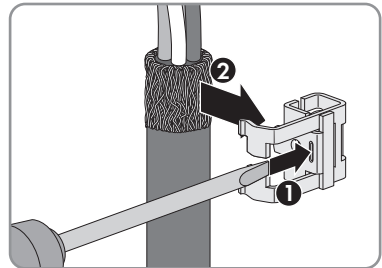

8 Commissioning the battery-backup system

1. Make sure that the product is correctly mounted and connected.
2. Insert the dead front and tighten the seven screws using a flat-blade screwdriver (torque: 0.5 Nm (4.4 lb-in)).
3. Lock up the product using the switch cabinet key.
4. Switch on the AC circuit breaker of the battery inverter and the PV system.
5. Reconnect to the utility grid.
6. Commission the inverters (see inverter manual).
7. Configure the battery-backup system via the user interface of the battery inverter:
 - Activate the battery inverter user interface.
 - Log in as **Installer**.
 - Start the installation assistant.
 - Select [**Start the installation assistant**] in the context menu.
 - Select [**Save and next**] up to the step **Configure battery-backup system**.
8. Test the automatic switch:
 - At the step **Configure battery-backup system**, select the operating mode **Force** in the drop-down list.
 - If the test has been completed successfully, you must select in the drop-down list the operating mode **Off** or **Automatic**.

9 Compliance Information

FCC Compliance

This device complies with Part 15 of the FCC Rules and with Industry Canada licence-exempt RSS standard(s).

Operation is subject to the following two conditions:

1. this device may not cause harmful interference, and
2. this device must accept any interference received, including interference that may cause undesired operation.

Le présent appareil est conforme aux CNR d'Industrie Canada applicables aux appareils radio exempts de licence.

L'exploitation est autorisée aux deux conditions suivantes :

1. l'appareil ne doit pas produire de brouillage, et
2. l'utilisateur de l'appareil doit accepter tout brouillage radioélectrique subi, même si le brouillage est susceptible d'en compromettre le fonctionnement.

NOTE: This equipment has been tested and found to comply with the limits for a Class B digital device, pursuant to Part 15 of the FCC Rules. These limits are designed to provide reasonable protection against harmful interference in a residential installation. This equipment generates, uses and can radiate radio frequency energy and, if not installed and used in accordance with the instructions, may cause harmful interference to radio communications. However, there is no guarantee that interference will not occur in a particular installation. If this equipment does cause harmful interference to radio or television reception, which can be determined by turning the equipment off and on, the user is encouraged to try to correct the interference by one or more of the following measures:

- Reorient or relocate the receiving antenna.
- Increase the separation between the equipment and receiver.
- Connect the equipment into an outlet on a circuit different from that to which the receiver is connected.
- Consult the dealer or an experienced radio/TV technician for help.

Changes or modifications made to this equipment not expressly approved by SMA Solar Technology AG may void the FCC authorization to operate this equipment.

IC Compliance

This Class B digital apparatus complies with Canadian ICES-003.

Cet appareil numérique de la classe B est conforme à la norme NMB-003 du Canada.

10 Technical Data

10.1 SBS-ABU-50-US-10 / SBS-ABU-100-US-10 / SBS-ABU-200-US-10

Connection to utility grid and household distribution

	SBS-ABU-50-US-10 (BUUS1-US-10)	SBS-ABU-100-US-10 (BUUM2-US-10)	SBS-ABU-200-US-10 (BUUM3-US-10)
Rated grid voltage	240 V	240 V	240 V
Output nom. voltage of line conductor	240 / 120 V	240 / 120 V	240 / 120 V
Rated power frequency	60 Hz	60 Hz	60 Hz
Maximum input and output current	50 A	100 A	200 A
Minimum cross-section in accordance with NEC when using 90 °C cables with an ambient temperature of 45 °C	16 mm ² (6 AWG)	35 mm ² (3 AWG)	120 mm ² (4/0 AWG)
Clamping range of terminals	0.75 mm ² to 16 mm ² (20 AWG to 6 AWG)	10 mm ² to 70 mm ² (8 AWG to 2/0 AWG)	70 mm ² to 150 mm ² (1/0 AWG to 300 kcmil)
Insulation stripping length L1/L2/N	18 mm (0.7 in)	30 mm (1.2 in)	40 mm (1.6 in)

Connection of PV inverters and battery inverters

	SBS-ABU-50-US-10 (BUUS1-US-10)	SBS-ABU-100-US-10 (BUUM2-US-10)	SBS-ABU-200-US-10 (BUUM3-US-10)
Maximum overcurrent protection of circuit breaker of PV inverter	30 A	50 A	50 A
Maximum overcurrent protection of circuit breaker of battery inverter	30 A	50 A	50 A
Clamping range of terminals N/PE	0.75 mm ² to 16 mm ² (20 AWG to 6 AWG)	0.75 mm ² to 16 mm ² (20 AWG to 6 AWG)	0.75 mm ² to 16 mm ² (20 AWG to 6 AWG)
Stripping length N/PE	18 mm (0.7 in)	18 mm (0.7 in)	18 mm (0.7 in)

	SBS-ABU-50-US-10 (BUUS1-US-10)	SBS-ABU-100-US-10 (BUUM2-US-10)	SBS-ABU-200-US-10 (BUUM3-US-10)
Clamping range of terminals L1/L2	1 mm ² to 25 mm ² (18 AWG to 4 AWG)	1 mm ² to 25 mm ² (18 AWG to 4 AWG)	1 mm ² to 25 mm ² (18 AWG to 4 AWG)
Torque of terminals L1/L2	2.8 Nm (24.8 in-lb)	2.8 Nm (24.8 in-lb)	2.8 Nm (24.8 in-lb)

10.2 General Data

Width x height x depth	500 mm x 700 mm x 250 mm (19.69 in x 27.56 in x 9.84 in)
Weight	approx. 60 kg (133 lbs)
Operating temperature range	-25°C to +60°C (-13°F to +140°F)
Maximum ambient temperature (without derating)	45°C (113°F)
Enclosure type in accordance with UL 50E	3R
Protection class	1
Grid configurations	240 V : 120 V split-phase system
Approvals and national standards, as per 08/2018	UL 1741

11 Contact

If you have technical problems with our products, please contact the SMA Service Line. The following data is required in order to provide you with the necessary assistance:

- Device type
- Serial number

United States	SMA Solar Technology America LLC Rocklin, CA	Toll free for USA and US Territories +1 877-MY-SMATech (+1 877-697-6283) International: +1 916 625-0870
Canada	SMA Solar Technology Canada Inc. Mississauga	Toll free for Canada / Sans frais pour le Canada : +1 877-MY-SMATech (+1 877-697-6283)
México	SMA Solar Technology de México Mexico City	Internacional: +1 916 625-0870

